



Welding Inspection

Welding Processes

Course Reference WIS 5

Welding

BS 499 part 1 Welding terms

A union between pieces of metal at faces rendered plastic or liquid by heat, pressure or both.

Possible energy sources

- Ultrasonic
- Electron beam
- Friction
- Electric resistance
- Electric arc

Welding Processes

Welding is regarded as a joining process in which the work pieces are in atomic contact

Solid state processes

- Forge welding
- Friction welding

Fusion welding processes

- Oxy-acetylene
- MMA (SMAW)
- MIG/MAG (GMAW)
- TIG/TAG (GTAW)
- Sub-arc (SAW)
- Electro-slag (ESW)

Fusion Welding Factors

The four essential factors for fusion welding

1. Fusion is achieved by melting using a high intensity heat source
2. The welding process must be capable of removing any oxide and contamination from the joint
3. Atmosphere contamination must be avoided
4. The welded joint must possess the mechanical properties required by the specification being adapted

Arc Welding Safety

Before continuing with the welding processes section, there are 2 safety related terms that should first be understood

“**Duty Cycle**” relates to the current carrying capacity of all conductors, based on a 10 minute cycle i.e. **60%** duty cycle means it can carry the specified current for 6 minutes in 10 then must rest for 4 minutes. A **100% duty cycle** has no rest period requirement. (Explained fully in the WIS 5 course notes)

Arc Welding Safety

OEL/MEL (Occupational or Maximum Exposure Limit) which is used in reference to fume exposure such as that caused in arc welding. The value may be in **PPM** or **mg/m³** depending on a particulate fume, or a gas. Typical values in EH/40 are

| Fume or gas | Exposure Limit | Effect on Health |
|----------------------|-------------------------------------------------------------|-------------------|
| Cadmium | 0.025Mg/m ³ | Extremely toxic |
| General Welding Fume | 5Mg/m ³ | Low toxicity |
| Iron | 5Mg/m ³ | Low toxicity |
| Aluminium | 5Mg/m ³ | Low toxicity |
| Ozone | 0.20 PPM | Extremely toxic |
| Phosgene | 0.02 PPM | Extremely toxic |
| Argon | No OEL Value O ² air content to be controlled | Very low toxicity |

Welding Processes

Manual Metal Arc Process . MM

TECHNOLOGY

USA: SMAW

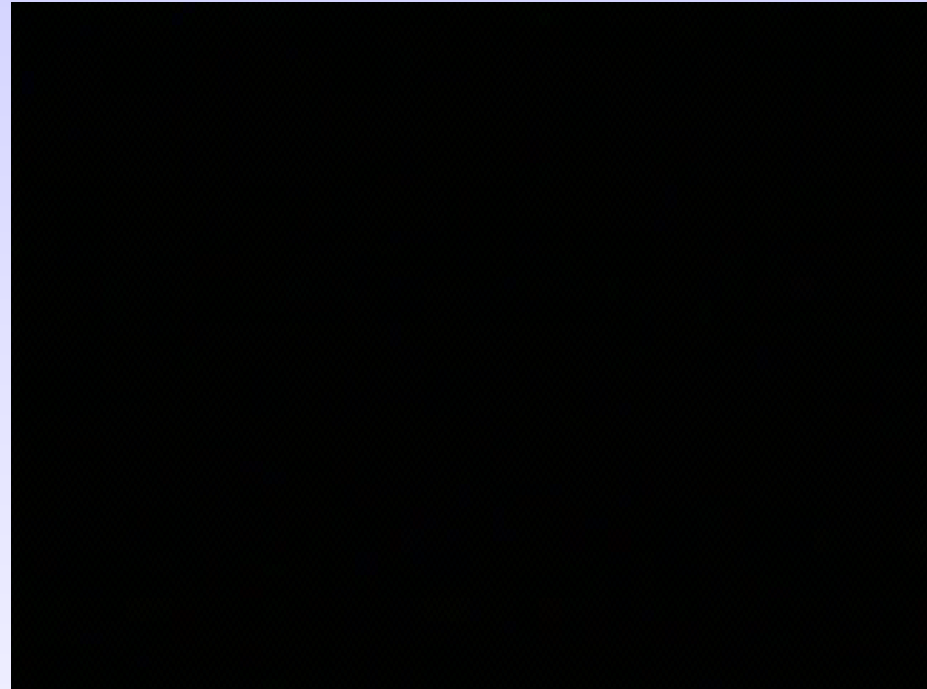
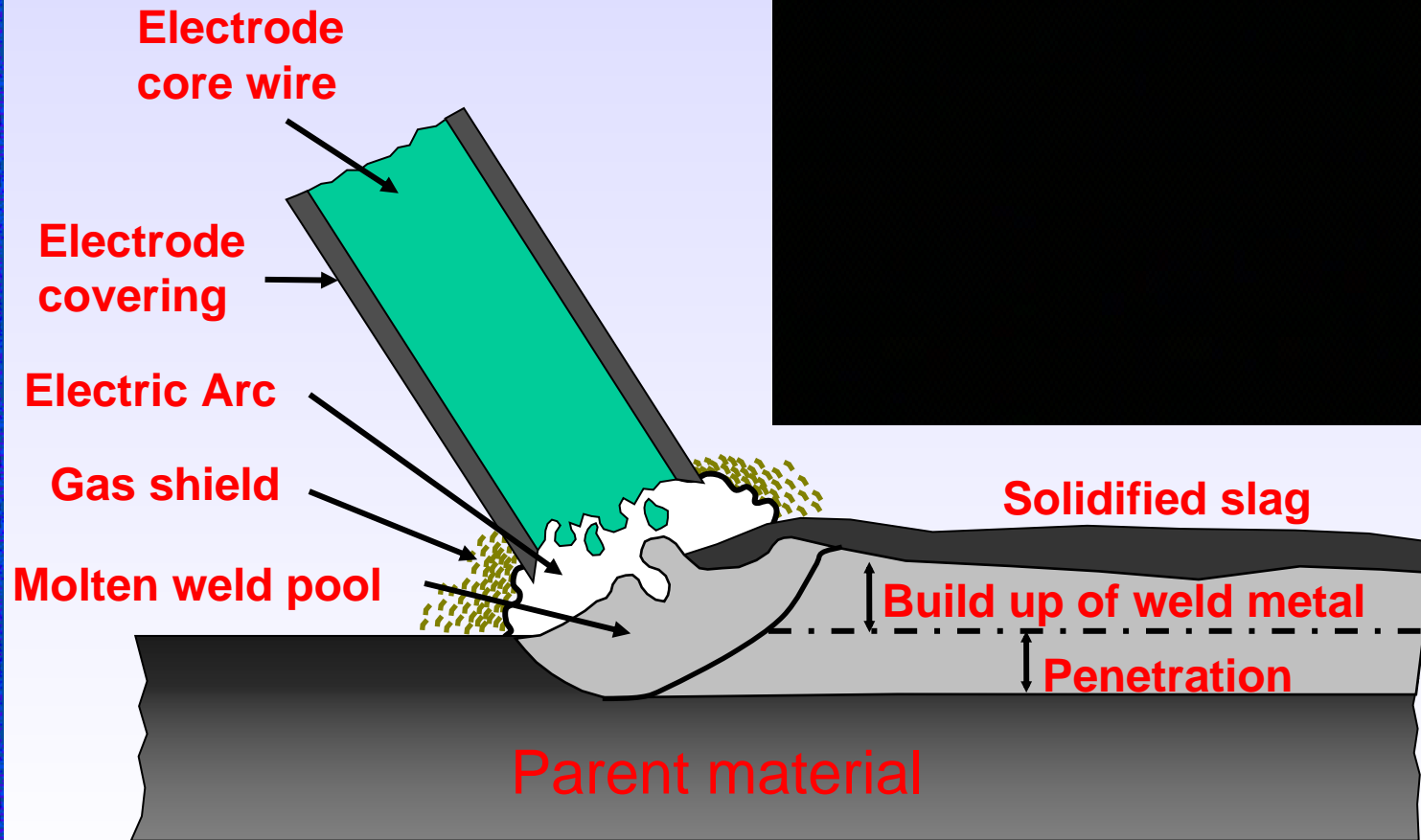

Manual Metal Arc Process

MM

Welding position has a big affect on weld quality.
More welder skill is required to weld in the **overhead position (4G)**, when compared to **down hand position (1G)**

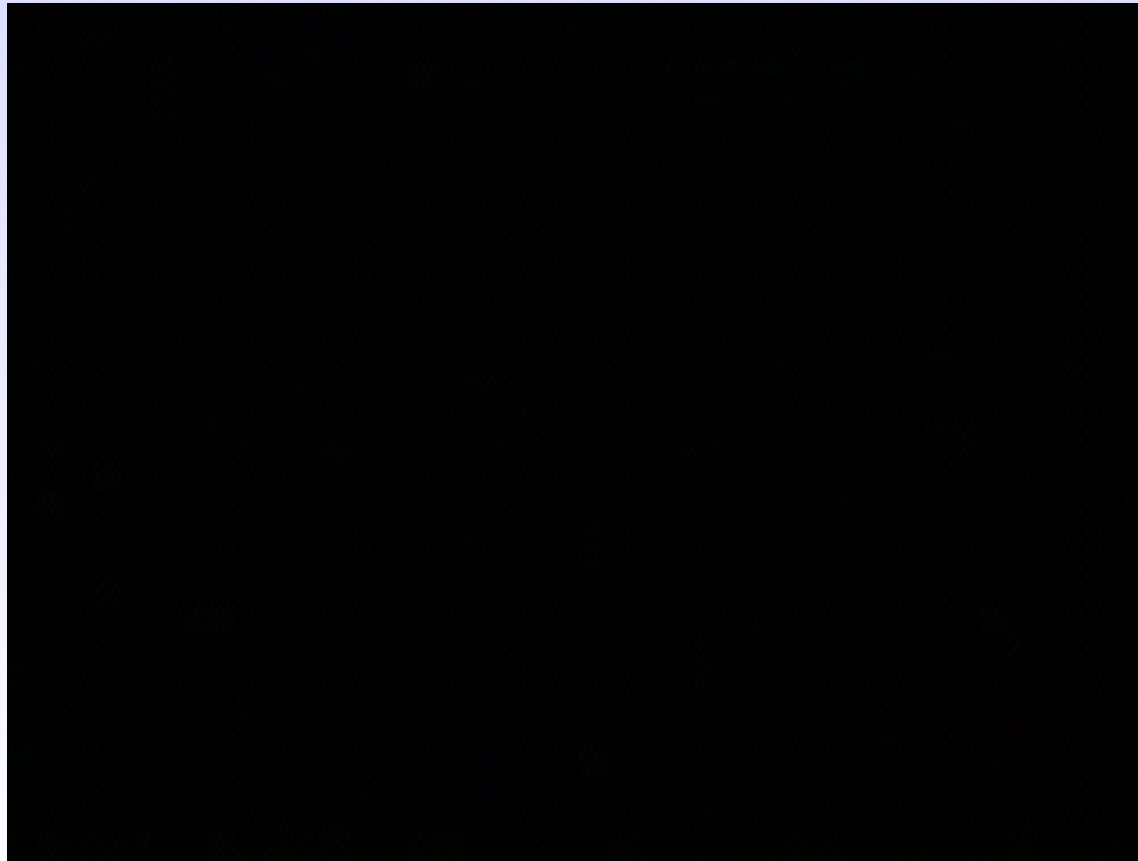

Manual Metal Arc Process . MM

In the **down hand position (1G)** the welder can drag the tip of the electrode along the joint. In the case of **vertical (3G)** and **overhead welding (4G)** the welder always gauges the arcs length

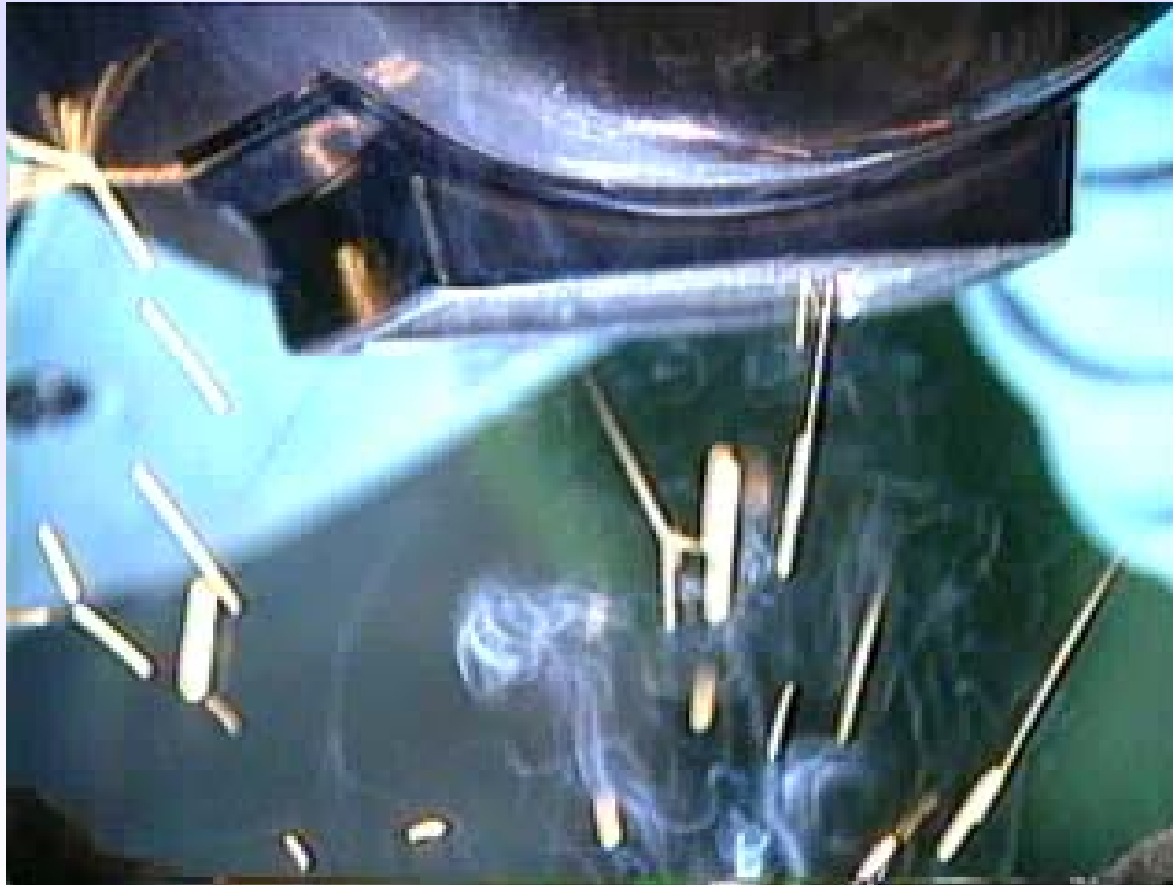

Manual Metal Arc Process

MM

Current (amps) primarily controls depth of penetration, the higher the current the deeper the penetration. If the current is too high this may lead to high spatter, undercut and the possibility of burn throughs



Manual Metal Arc Process . . MM

Arc length is another important consideration in weld quality. If the arc length is too short the arc will become unstable and may short circuit. If the arc length is too long this causes high spatter and incorrect shielding from the atmosphere.

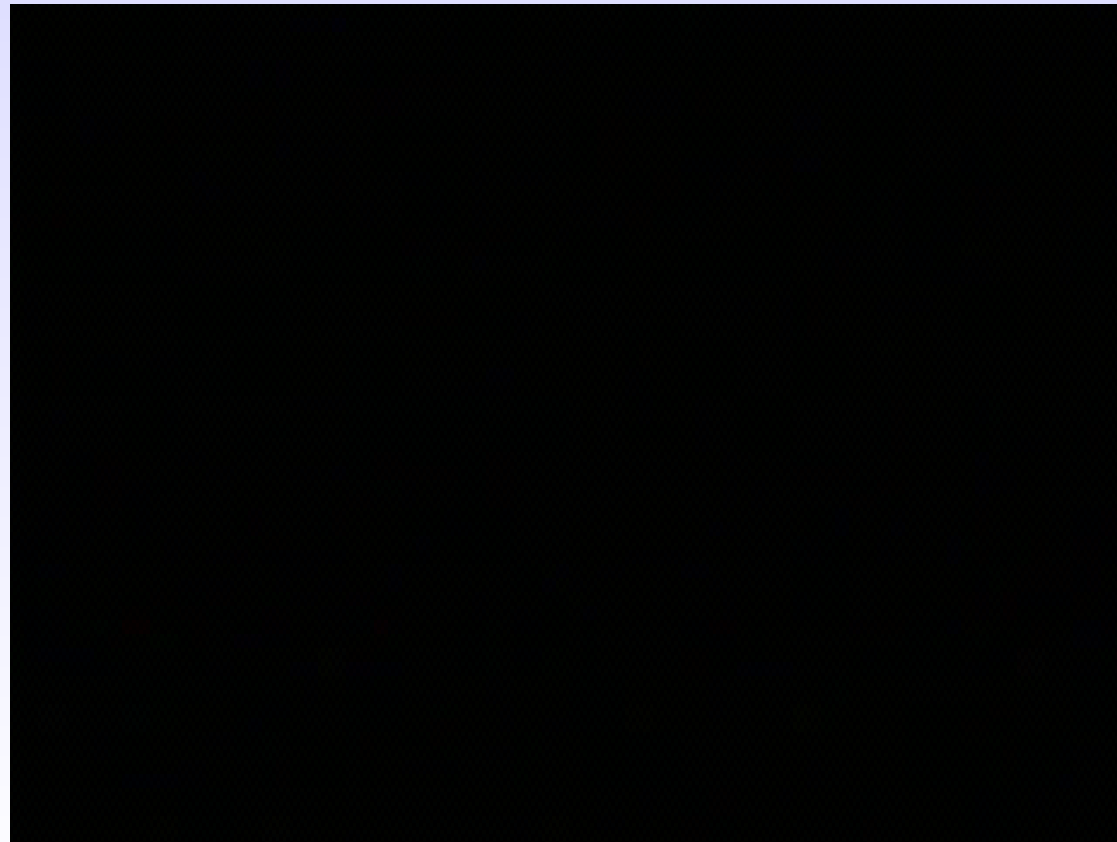

Manual Metal Arc Process . MM

Arc length is another important consideration in weld quality. If the arc length is too short the arc will become unstable and may short circuit. If the arc length is too long this causes high spatter and incorrect shielding from the atmosphere.



~~Drooping or Constant Current~~

Characteristic

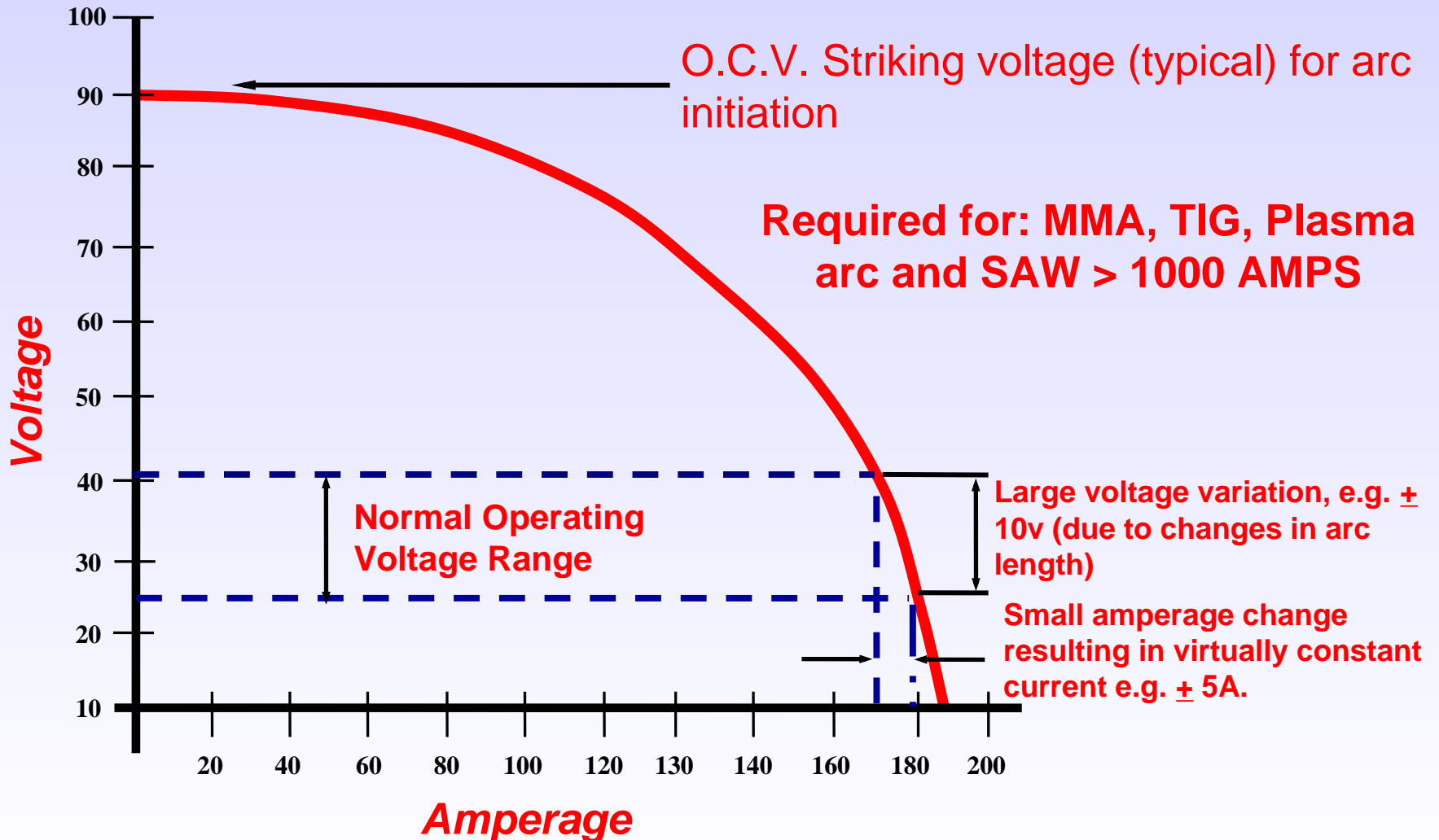

MMA Welding Basic Equipment



Manual Metal Arc Process MMA

Welder controls

- Arc length
- Angle of electrode
- Speed of travel

Welding Plant

- **Transformer:**
Changes mains supply voltage to a voltage suitable for welding. Has no moving parts and is often termed static plant.
- **Rectifier:**
Changes a.c. to d.c., can be mechanically or statically achieved.
- **Generator:**
Produces welding current. The generator consists of an armature rotating in a magnetic field, the armature must be rotated at a constant speed either by a motor unit or, in the absence of electrical power, by an internal combustion engine.
- **Inverter:**
An inverter changes d.c. to a.c. at a higher frequency.

Parameters

Voltage

The arc voltage in the MMA process is measured as close to the arc as possible. It is variable with a change in arc length

O.C.V.

The open circuit voltage is the voltage required to initiate, or re-ignite the electrical arc and will change with the type of electrode being used e.g 70-90 volts

Current

The current used will be determined by the choice of electrode, electrode diameter and material type and thickness. Current has the most effect on penetration.

Polarity

Polarity is generally determined by operation and electrode type e.g DC +ve or DC -ve

Manual Metal Arc MMA

The three main electrode covering types used in MMA welding

- Rutile - general purpose
- Basic - low hydrogen
- Cellulose - deep penetration/fusion

Checks when MMA Welding

The welding equipment

A visual check should be made on the equipment to ensure it is in good working order

The electrodes

Checks should be made to ensure that the correct specification of electrode is being used, the electrode is the correct diameter and in good condition. In the case of basic fluxed electrodes ensure the correct heat treatment is being carried out before use

e.g Baked at 350oC, holding 150oC, quiver temps 70oC

Cellulose and rutile electrodes do not require pre-baking but should be stored in a dry condition.

Checks when MMA Welding

OCV open circuit volts

A check should be made to ensure that the equipment can produce the OCV required by the consumable and that any voltage selector has been moved to the correct position

Current & polarity

A check should be made to ensure the current type and range is as detailed on the WPS

Other variables

Checks should be made for correct electrode angle, arc gap and travel speed

Safety

Advantages . . .

~~Disadvantages~~**Advantages**

- Field or shop use
- Range of consumables
- All positions
- Portable
- Simple equipment

Disadvantages

- High welder skill required
- Low operating factor*
- High levels of fume
- Hydrogen control (flux)
- Stop/start problems

*** Comparatively uneconomic when compared with some other processes i.e MAG, SAW and FCAW**

Arc Blow ~ Wander

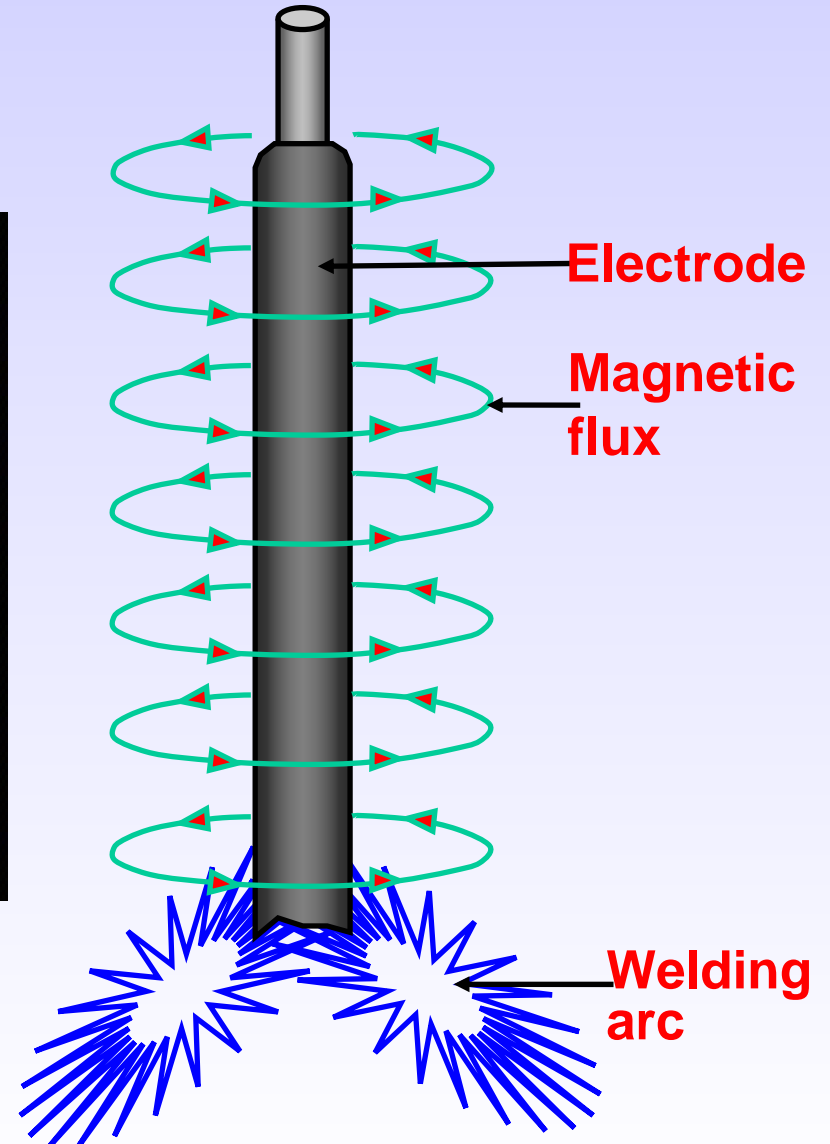

Arc Blow ~ Wander

- Arc blow is the deviation of the arc due to magnetic influences.
- Arc blow occurs using DC current only
- The occurrence of arc blow may cause the following problems
- Poor penetration/fusion
- Poor cap profiles
- High spatter
- General manipulation problems

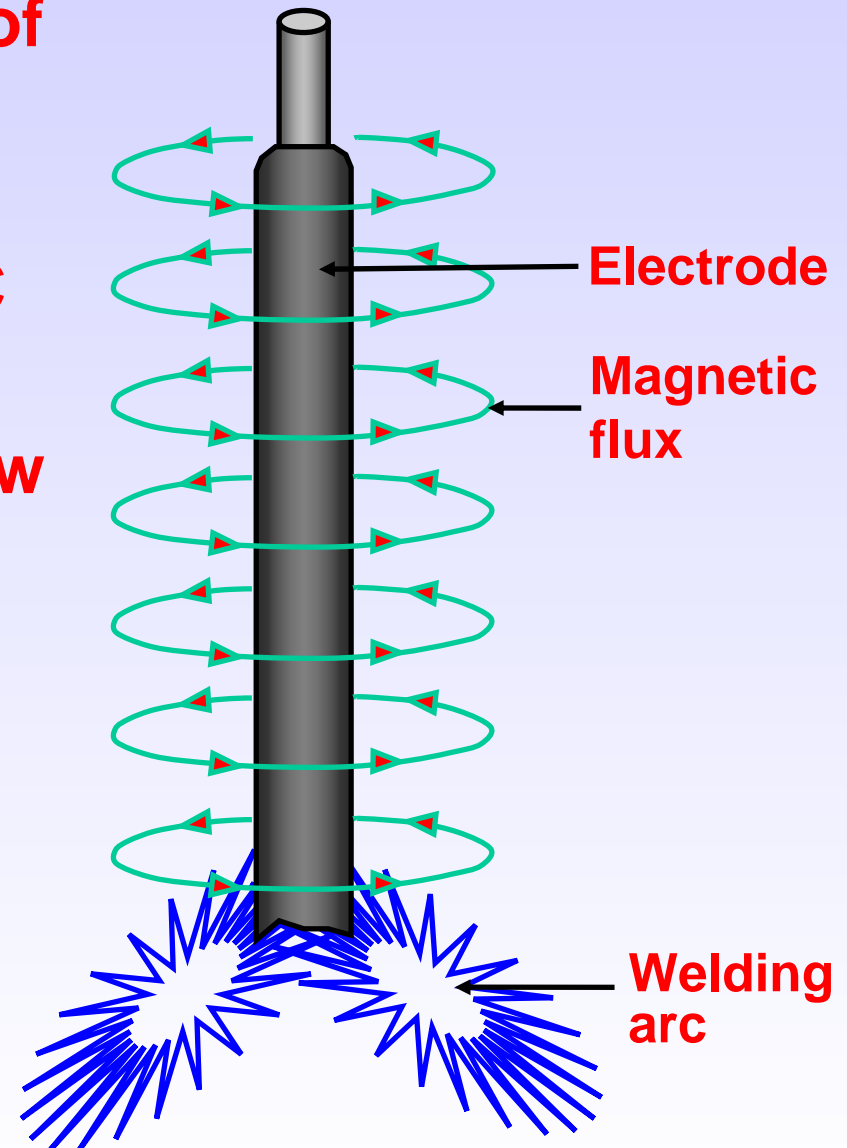

Precautions Against Arc Bl

- If the procedure allows change welding current from d.c. to a.c.
- Hold as short an arc as possible.
- Reduce welding current (within the procedures range)
- Reduce welding voltage within the procedures range
- Change the electrodes angle, opposite to the arc blows direction.
- If possible weld towards heavy tack welds or previously deposited welds.
- Wrap ground cables (return leads) around the work piece or the welder.
- De-magnetise component being welded



Any Questions

TECHNOLOGY



Questions

- QU 1. State the main welding parameters of the MMA welding process
- QU 2. What type of power source characteristic is considered essential for a MMA welding plant?
- QU 3. Give the main advantages of the MMA welding process when compared to the MAG welding process
- QU 4. State the four criteria that will govern the number of weld passes in a MMA welded joint
- QU 5. State two types of electrical supply and give the advantages of each

Tungsten Inert Gas . TIG .

TECHNOLOGY

USA: GTAW

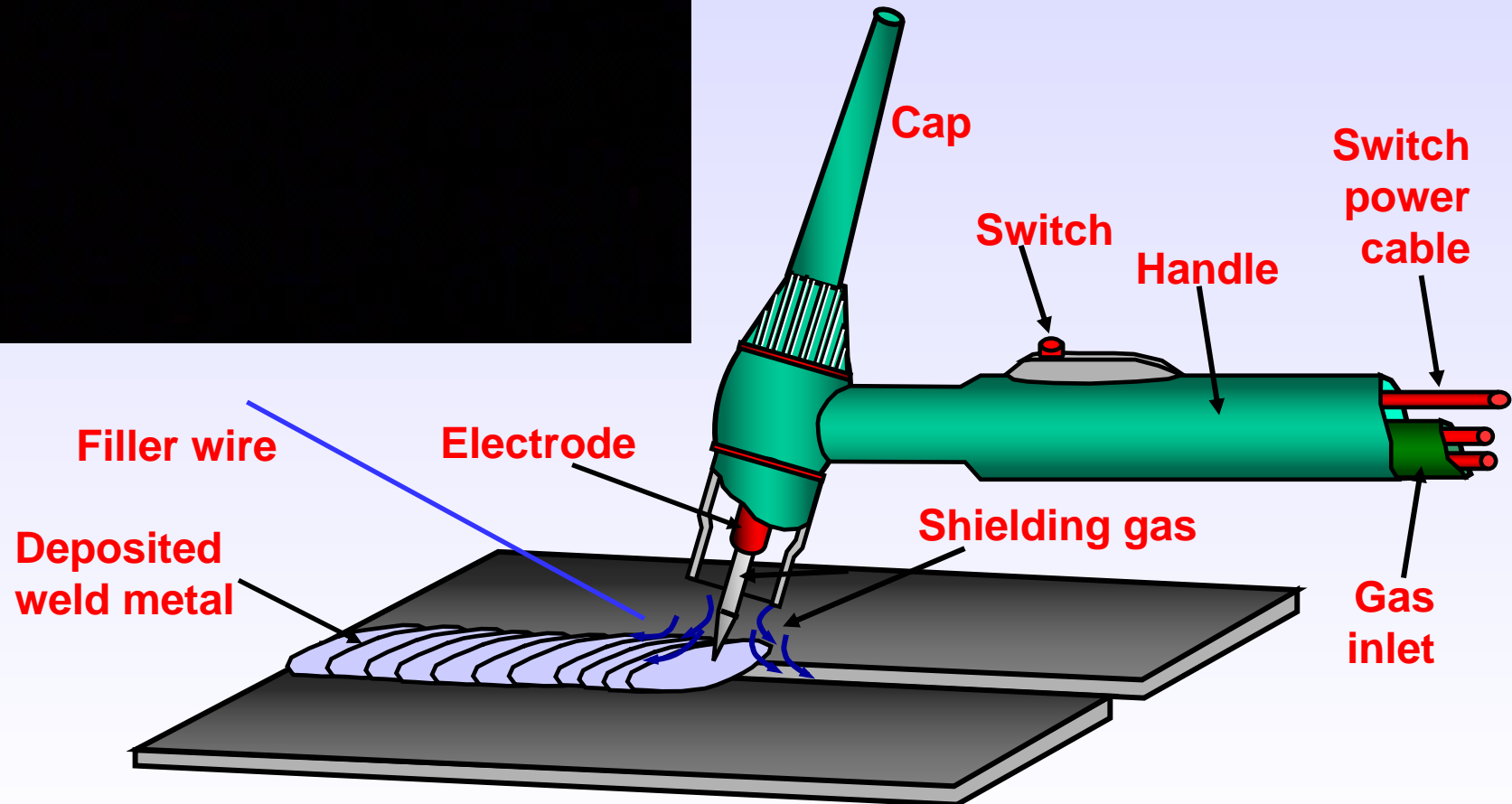
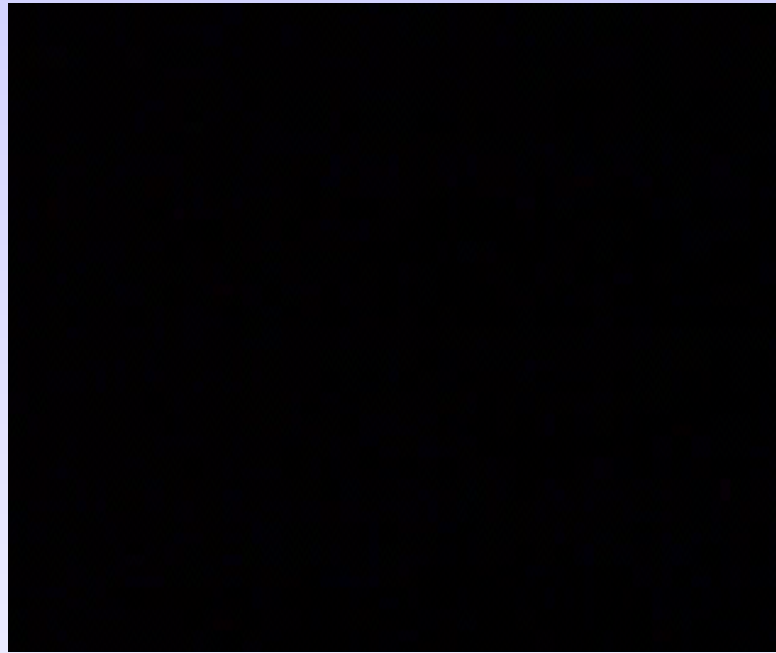

TIG Welding Basic

Equipment

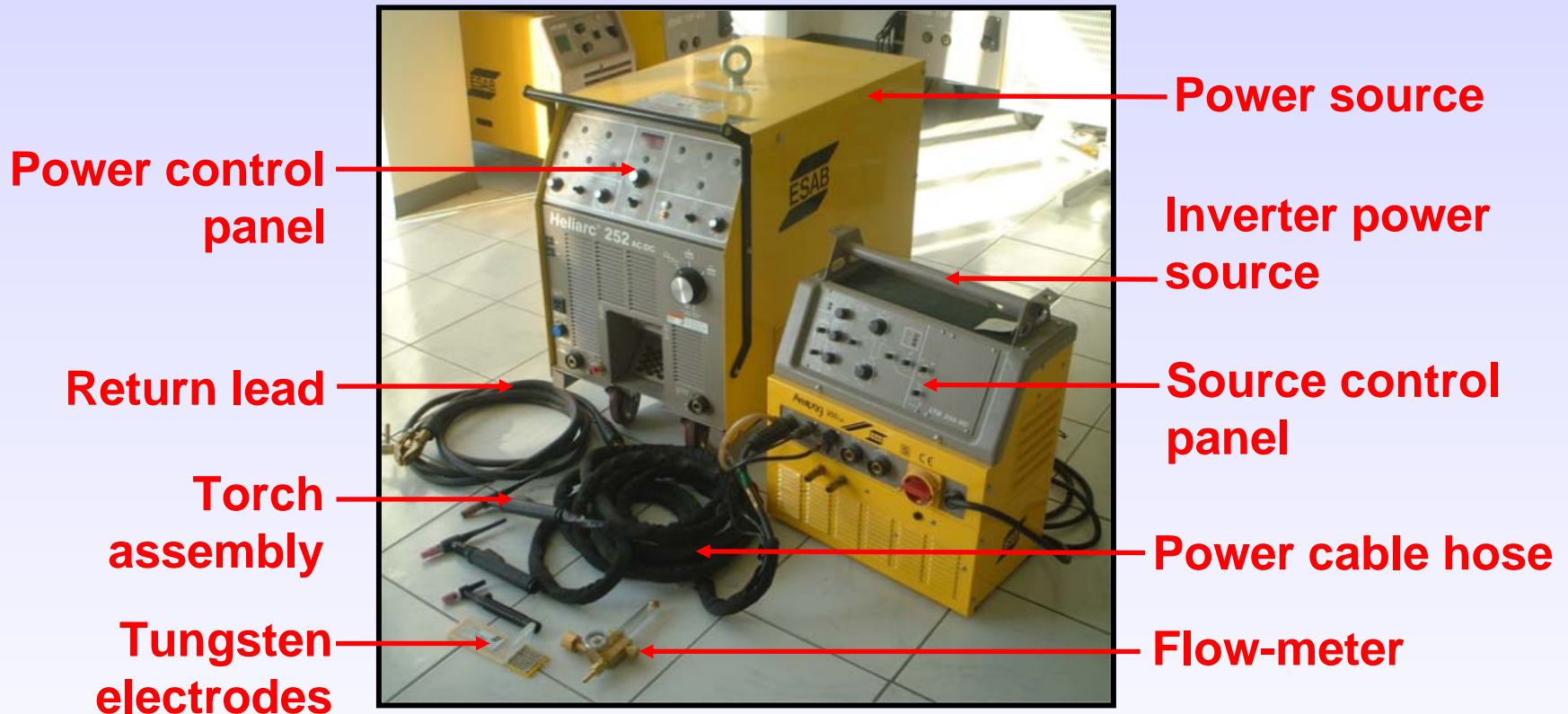

TIG Torch Assembly

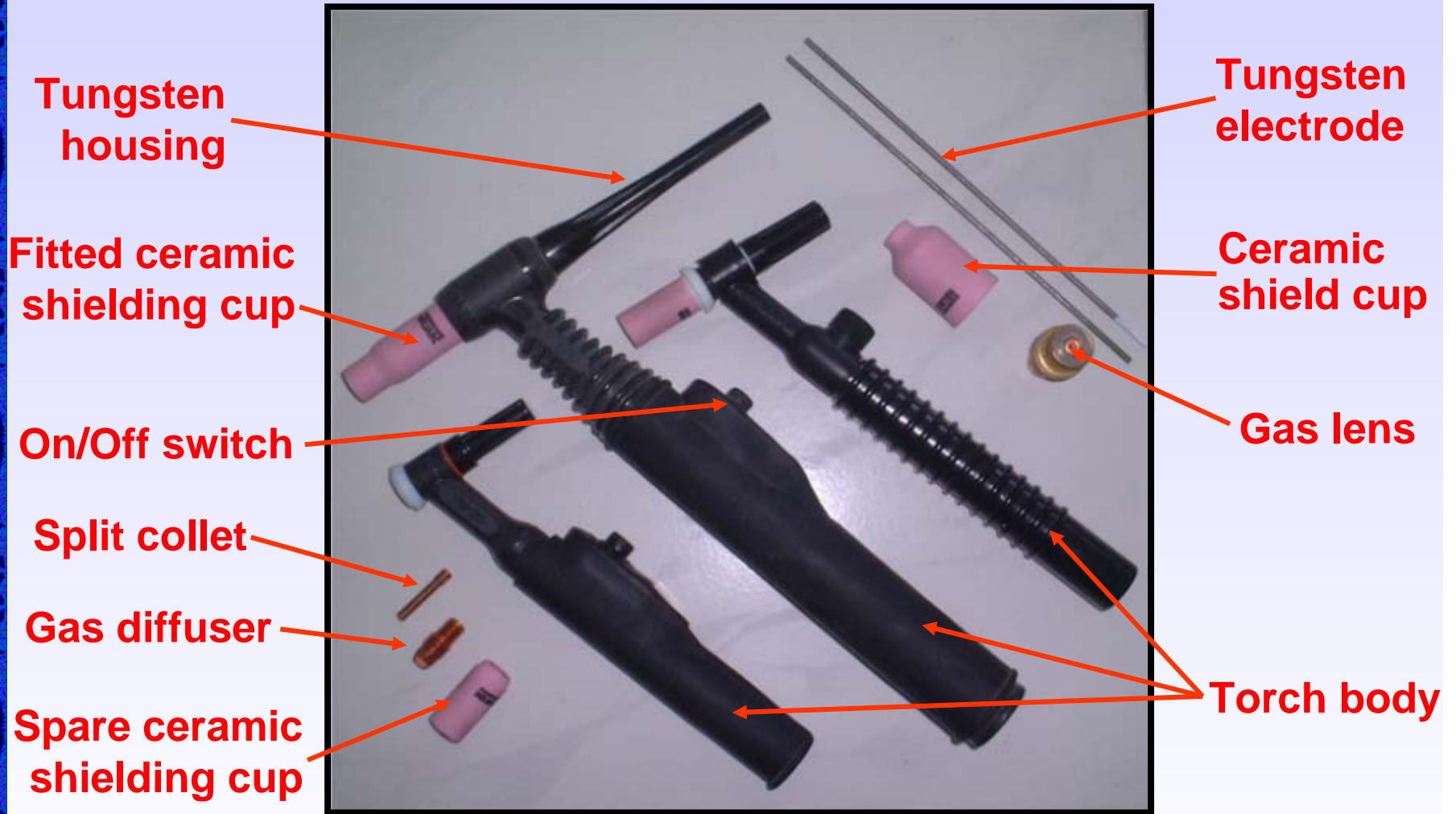

Parameters

Voltage

The voltage of the TIG welding process is variable only by the type of gas being used, and changes in the arc length

Current

The current is adjusted proportionally to the tungsten electrodes diameter being used. The higher the current the deeper the penetration and fusion

Polarity

The polarity used for steels is always DC -ve as most of the heat is concentrated at the +ve pole, this is required to keep the tungsten electrode at the cool end of the arc. When welding aluminium and its alloys AC current is used

Parameters

Tungsten electrodes

The electrode diameter, type and vertex angle are all critical factors considered as essential variables. The vertex angle is as shown

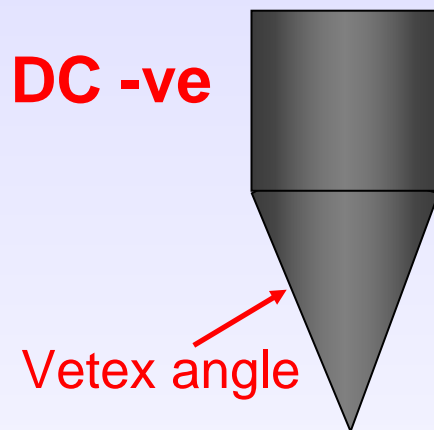

Note: too fine an angle will promote melting of the electrodes tip

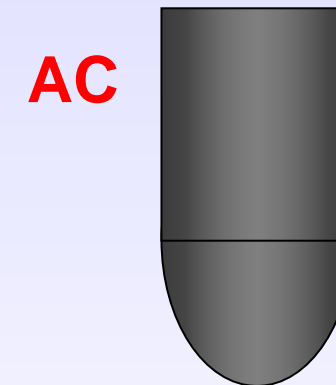

Note: when welding aluminium with AC current, the tungsten end is chamfered and forms a ball end when welding

Tungsten Electrodes

Old types

- Thoriated: DC -ve electrode - steels and most metals
- 1% thoriated + tungsten for higher current values
- 2% thoriated for lower current values
- Zirconiated: AC - aluminum alloys and magnesium

New types

- Cerium: DC -ve electrode - steels and most metals
- Lanthanum: AC - Aluminum alloys and magnesium

Tungsten Electrodes

| <u>Metal Thickness</u> mm | <u>Joint Type</u> | <u>Tungsten Diameter</u> mm | <u>Filler Rod Diameter</u> mm | <u>Amperage</u> | <u>Shielding Gas</u> | <u>Flow Rate</u> L/mm |
|------------------------------|---------------------------------|--------------------------------|----------------------------------|------------------------------------------|----------------------|--------------------------|
| 1.5 | Butt Lap Corner Fillet | 1.6 | 1.5 | 60-70 70-90 60-70 70-90 | Argon | 8 |
| 3.0 | Butt Lap Corner Fillet | 1.6-2.4 | 2.4 | 80-100 90-115 80-100 90-115 | Argon | 8 |
| 5.0 | Butt Lap Corner Fillet | 2.4 | 3.2 | 115-135 140-165 115-135 140-170 | Argon | 10 |
| 6.0 | Butt Lap Corner Fillet | 3.2 | 4.0 | 160-175 170-200 160-175 175-210 | Argon | 10 |

Parameters

Gas type and flow rate

Generally two types of gases are used in TIG welding, argon and helium, though nitrogen may be considered for welding copper and hydrogen may be added for the welding of austenitic stainless steels. The gas flow rate is also an important

Argon (Ar) Inert

- Suitable for welding carbon steel, stainless steel, aluminium and magnesium
- Lower cost, lower flow rates
- More suitable for thinner materials and positional welding

Helium Argon mixes

- Suitable for welding carbon steel, stainless steel, copper, aluminium and magnesium
- High cost, high flow rates
- More suitable for thicker materials and materials of high thermal conductivity.

Tungsten Inert Gas Welding

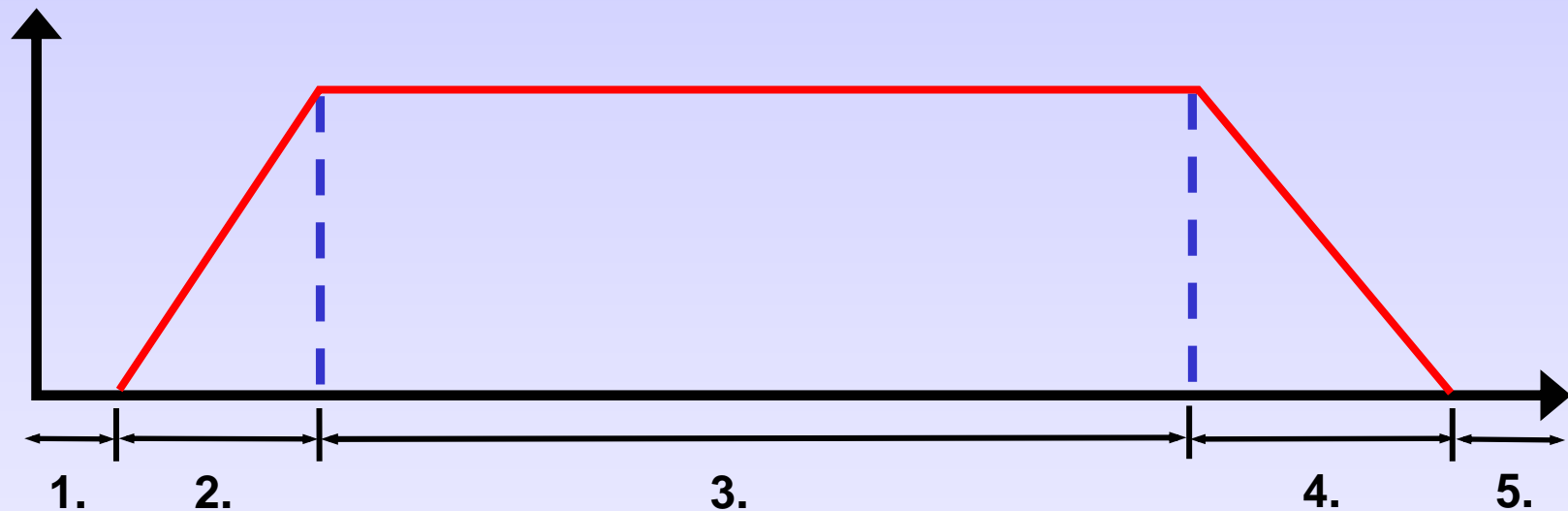

1. Pre-flow timer control

Adjusts the time the gas and water valves are open

2. Up-Slope control (Slope-In)

Prevents burn throughs and the possibility of tungsten inclusions

3. Output control

Welding current control

4. Down-Slope control (Slope-out)

Crater fill and controls crater pipe and the possibility of crater cracks

5. Post-flow timer control

Adjusts the time the gas flows after welding

Checks when TIG Welding

The welding equipment

A visual check should be made to ensure the welding equipment is in good condition

The torch head assembly

Check the diameter and specification of the tungsten electrode, the required vertex angle and that a gas lens is fitted correctly. Check the electrode stick-out length and that the ceramic is the correct type and in good condition

Gas type and flow rate

Check the shielding gas is the correct type, or gas mixture and the flow rate is correct for the given joint design, welding position as stated in the WPS

Checks when TIG Welding

Current and polarity

Checks should be made to ensure that the type of current and polarity are correctly set, and the range is within that given on the procedure.

Other welding parameters

Checks should be made to other parameters such as torch angle, arc gap distance and travel speed.

Safety

Check should be made on the current carrying capacity, or duty cycle of the equipment and all electrical insulation is sound and in place. Correct extraction systems should be in use to avoid exposure to toxic fume.

Advantages . . .

~~Disadvantages~~

Advantages

- High quality
- Good control
- All positions
- Low hydrogen
- Minimal cleaning

Disadvantages

- High skill factor required
- Small consumable range
- High protection required
- Low productivity
- High ozone levels



Any Questions

TECHNOLOGY



Questions

- QU 1. Give three reasons for the occurrence of tungsten inclusions
- QU 2. State the main welding parameters with the TIG welding process
- QU 3. Which electrode polarity is considered essential for the welding of carbon steel? And give a brief description why
- QU 4. Which electrode polarity is considered essential for the welding of aluminium? And give a brief description why
- QU 5. State the tungsten electrode activators required to weld carbon steel and the light alloys
- QU 5. State the main advantages and disadvantage of the TIG welding process

Metal Active Inert Gas . . . MAG ~ MIG .

TECHNOLOGY

USA: GMAW

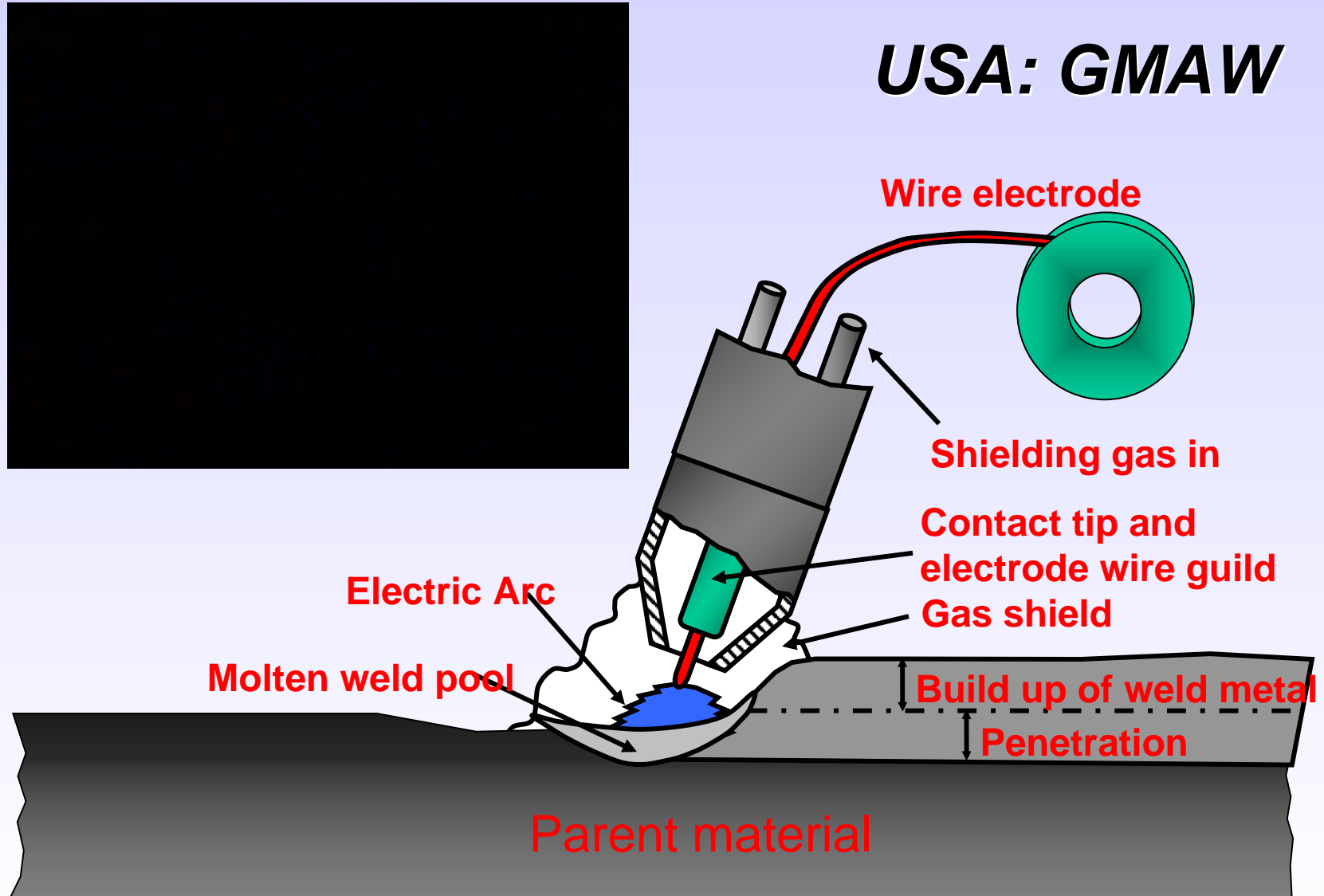

Flat or constant voltage characteristics

Flat or Constant Voltage Characteristic Used With MIG/MAG, ESW & SAW < 1000 amps

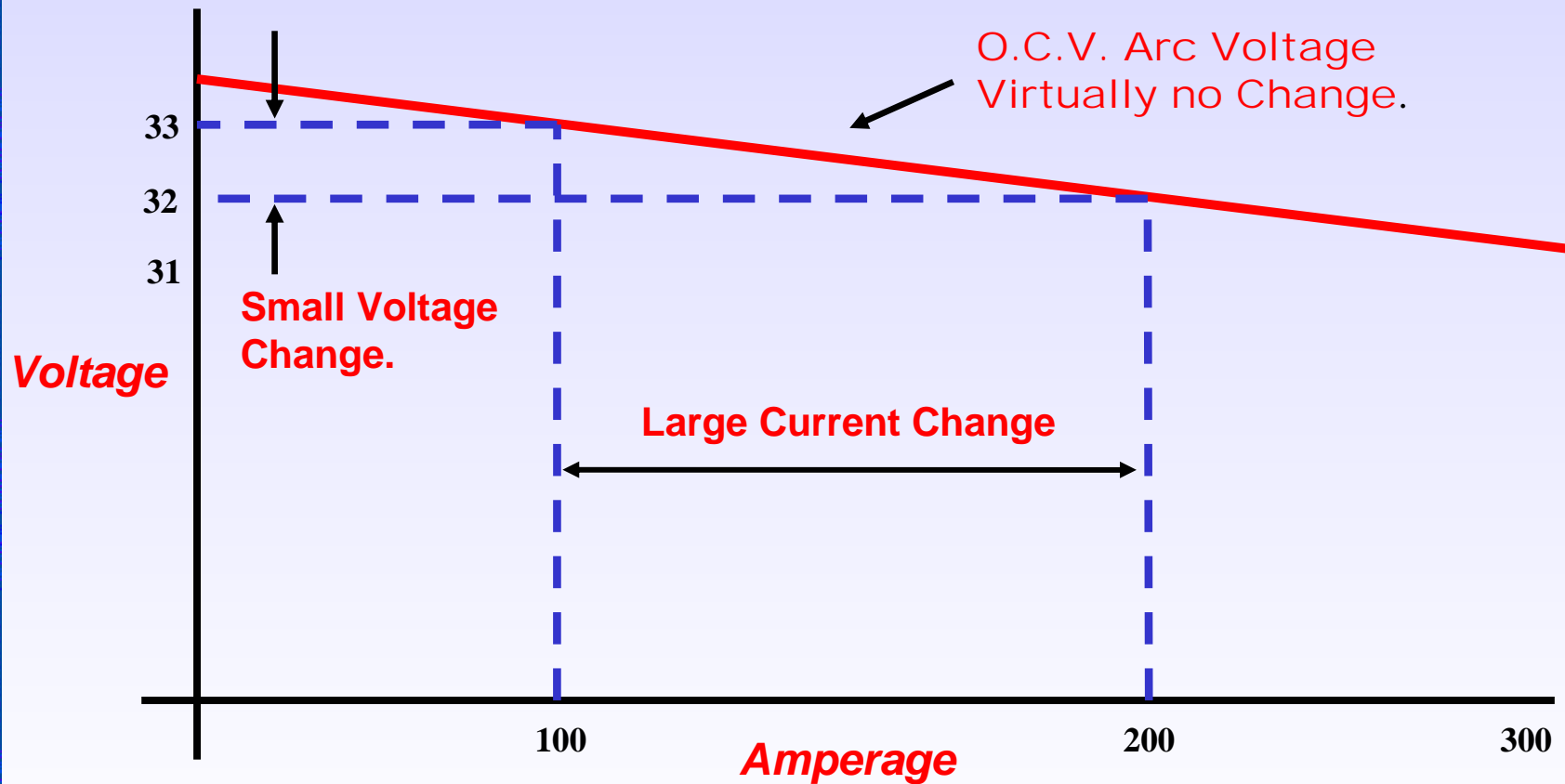

MAG Welding Basic Equipment

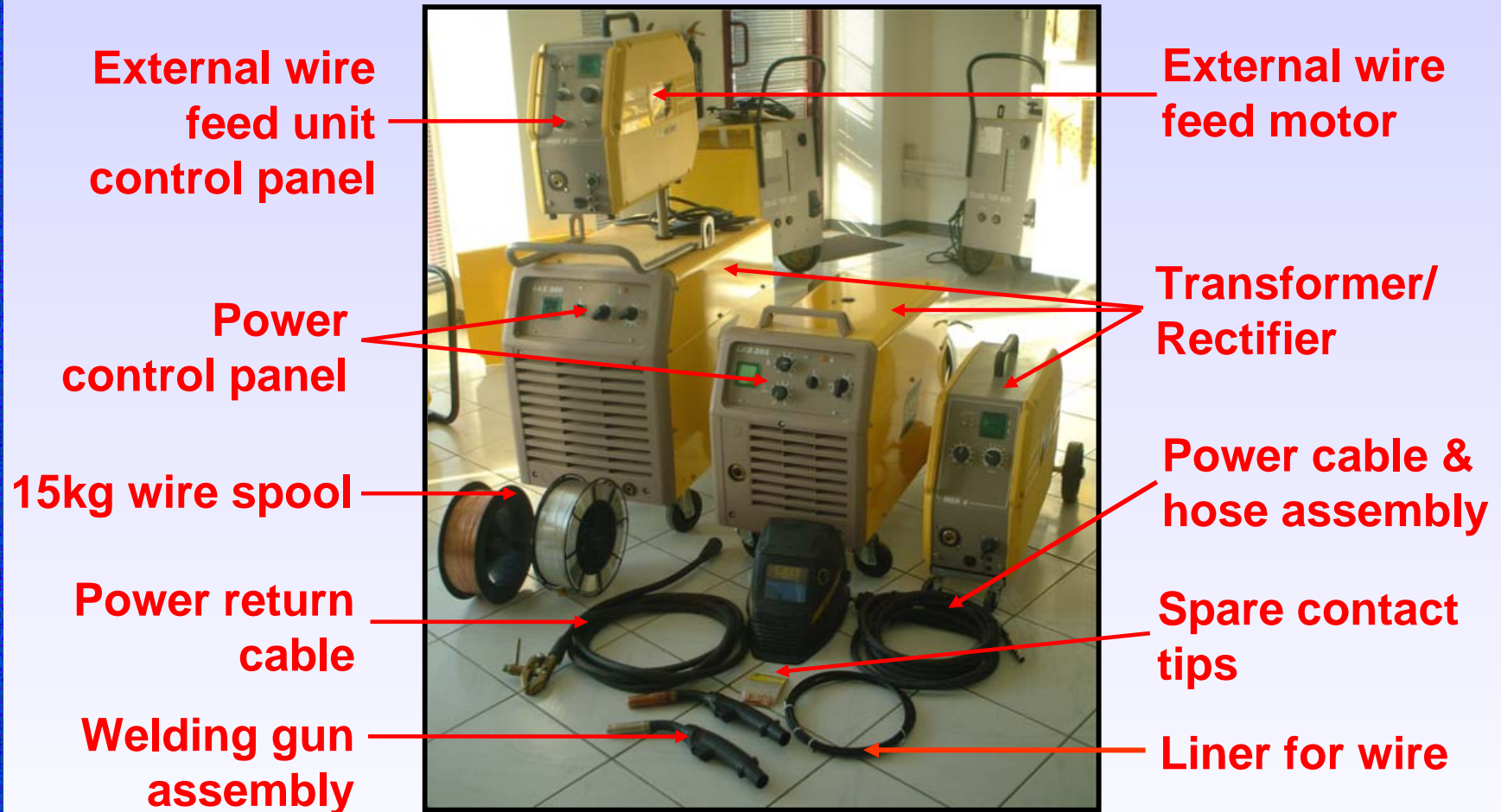

MAG ~ MIG Torch Head Assembly

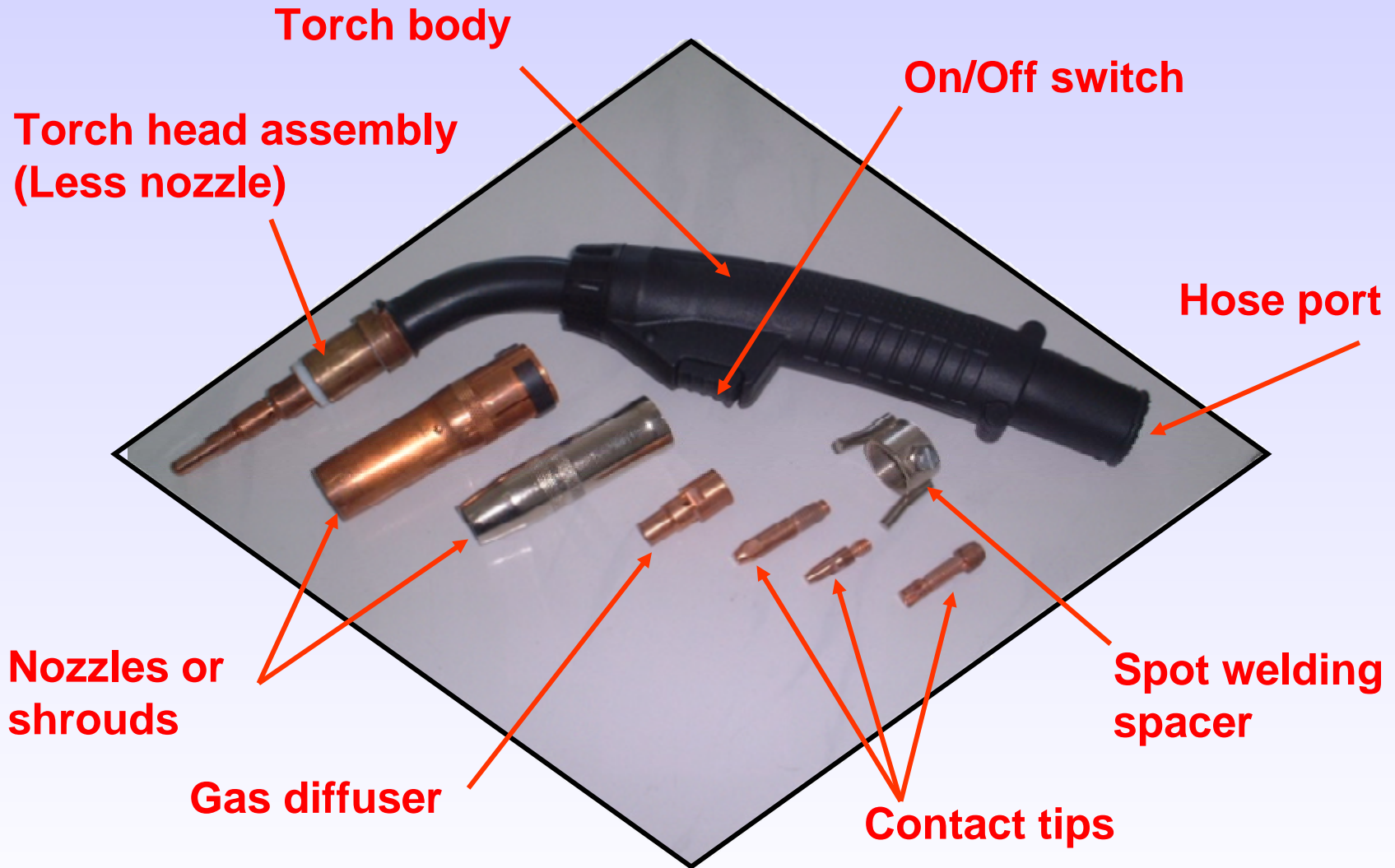

MAG~MIG Internal Wire Drive

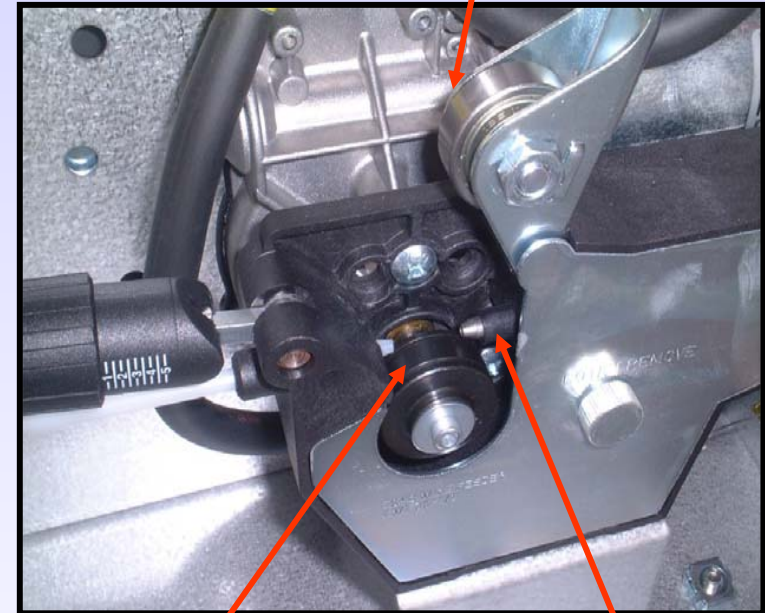
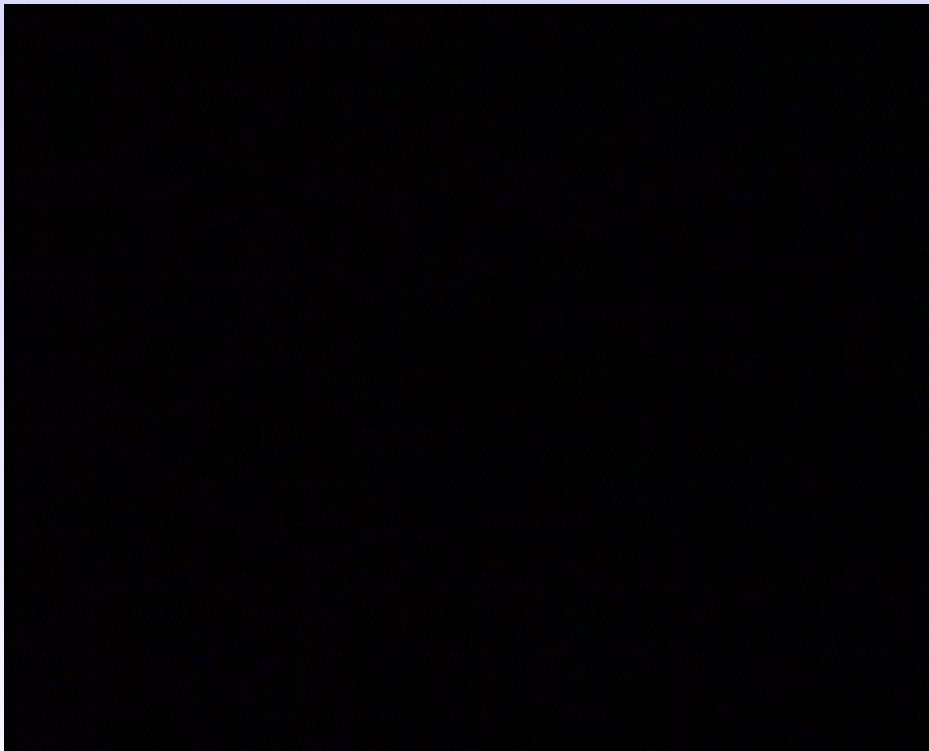

Plain top roller

Half grooved bottom roller

Wire guide

Metal Transfer Modes for MAG

- **Dip Transfer: Voltage < 22 Amperage < 200**
Thin materials positional welding



Metal Transfer Modes for MAG

- **Spray Transfer: Voltage > 27 Amperage > 220**
Thicker materials, limited to flat welding positions, high deposition.



Metal Transfer Modes for MAG

- **Globular Transfer: Between Dip & Spray Transfer**
Limited commercial, Used only in some mechanised MAG process using CO₂ shielding gas

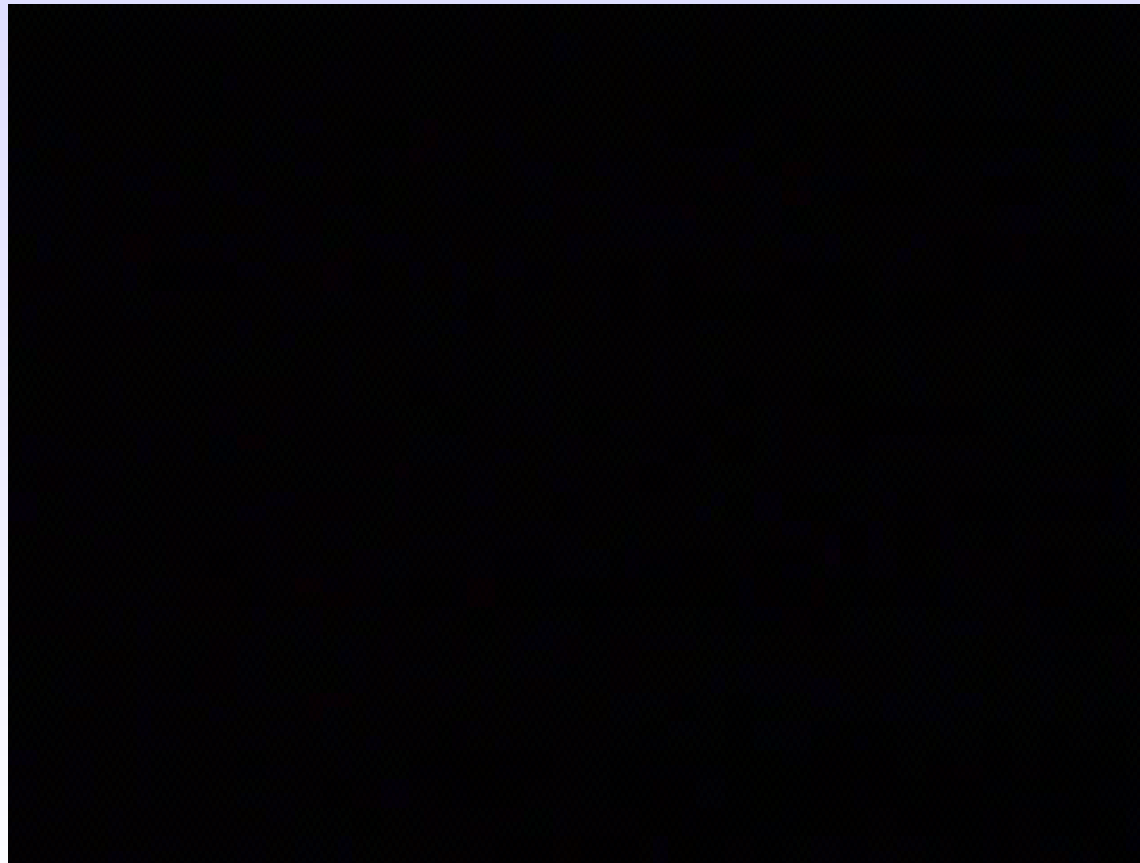

Metal Transfer Modes for MAG

- **Dip Transfer:** Voltage < 22 Amperage < 200
Thin materials positional welding
- **Globular Transfer:** Between Dip & Spray Transfer
Limited commercial, Used only in some mechanised MAG process using CO₂ shielding gas
- **Spray Transfer:** Voltage > 27 Amperage > 220
Thicker materials, limited to flat welding positions, high deposition
- **Pulse Transfer:** Both spray and dip transfer in one mode of operation, frequency range 50-300 pulses/second
Positional welding and root runs

Parameters

Wire feed speed

Increasing the wire feed speed automatically increases the current in the wire

Voltage

The voltage is the most important setting in the spray transfer mode, as it controls the arc length. In dip transfer it controls the rise in current

Current

The current is automatically increased as the wire feed is increased. Current mainly affects penetration

Parameters

Gasses

The gasses used in MIG/MAG welding can be either 100% CO₂ or Argon + CO₂ mixes.

- 100% CO₂: Can not sustain true spray transfer, but gives very good penetration. The arc is unstable which produces a lot of spatter and a coarse weld profile.
- Argon + CO₂ mixes: Argon can sustain spray transfer above 24 volts, and gives a very stable arc with a reduction in spatter. Argon being a cooler gas produces less penetration than CO₂. Argon is normally mixed with CO₂ at a mixture of between 5-20%

Parameters

Inductance

- Applicable to MIG/MAG process in dip transfer mode.
- The electrode is fed slowly through the arc until it touches the weld pool, at this point the output from the power supply is short circuited and a very high current flows through the electrode. If this was allowed to continue, the wire would melt and eject excessive amounts of spatter.
- The inclusion of the choke in the welding circuit controls the rate at which the current rises so that the electrode tip is melted uniformly without excessive spatter

Checks when MIG ~ MAG Welding

The welding equipment

A visual check should be made on the equipment to ensure it is in good working order

The electrodes

The diameter, specification and the quality of the wire are essential for inspection. The level of deoxidisation in the wire, single, double or triple de-oxidised. The quality of the wire winding and the copper coating should also be inspected to minimize wire feed problems.

Checks when MIG ~ MAG Welding

Wire liner

Check that the liner is the correct type and size for the wire being used. Steel liners for steel and Teflon liners for aluminium.

Contact tips

Check the tip is the correct size for the wire being used and check the amount of wear. Excessive wear will affect wire speed and electrical current pick-up

Gas and gas flow-rates

Type of gas and the flow rate need to be checked to ensure they comply with the WPS

Other welding variables

Check WFS, amps, volts and travel speed

Flux Cored Arc Welding

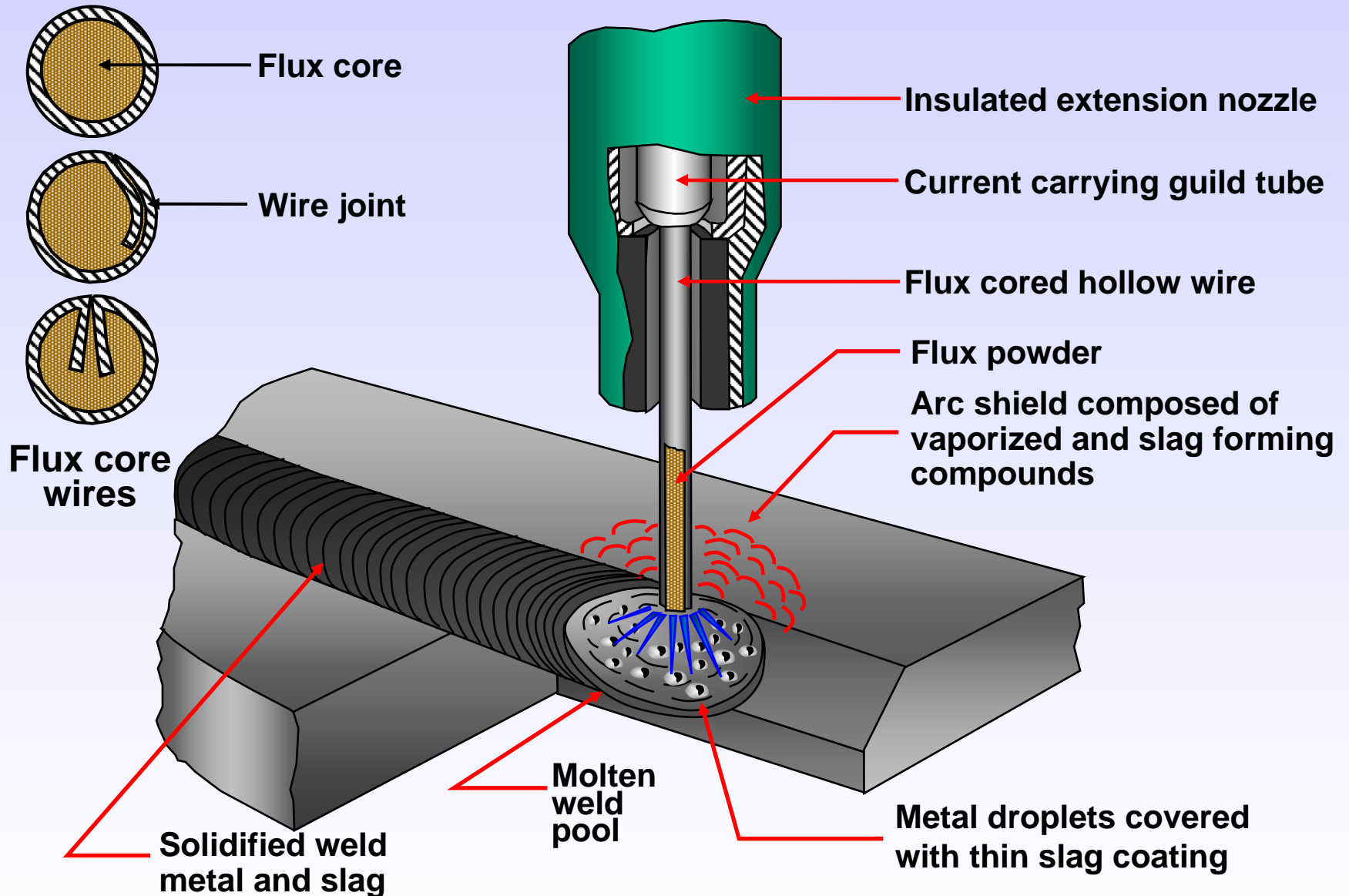

TECHNOLOGY

Advantages . . .

~~Disadvantages~~**Advantages**

- High productivity
- Easily automated
- All positional (dip & pulse)
- Material thickness range
- Continuous electrode

Disadvantages

- Lack of fusion (dip)
- Small range of consumables
- Protection on site
- Complex equipment
- Not so portable



Any Questions

TECHNOLOGY



Questions

- QU 1. State the possible problems when using the dip transfer mode in the MAG welding process
- QU 2. State the application areas for the spray transfer mode when using the MAG welding process.
- QU 3. What power source characteristic is required and electrode polarity/current type for the MAG welding process
- QU 4. State the main variables for the MAG welding process
- QU 5. State the advantages and disadvantages of the MAG welding process when compared to MMA

Sub arc Welding.

SAW.

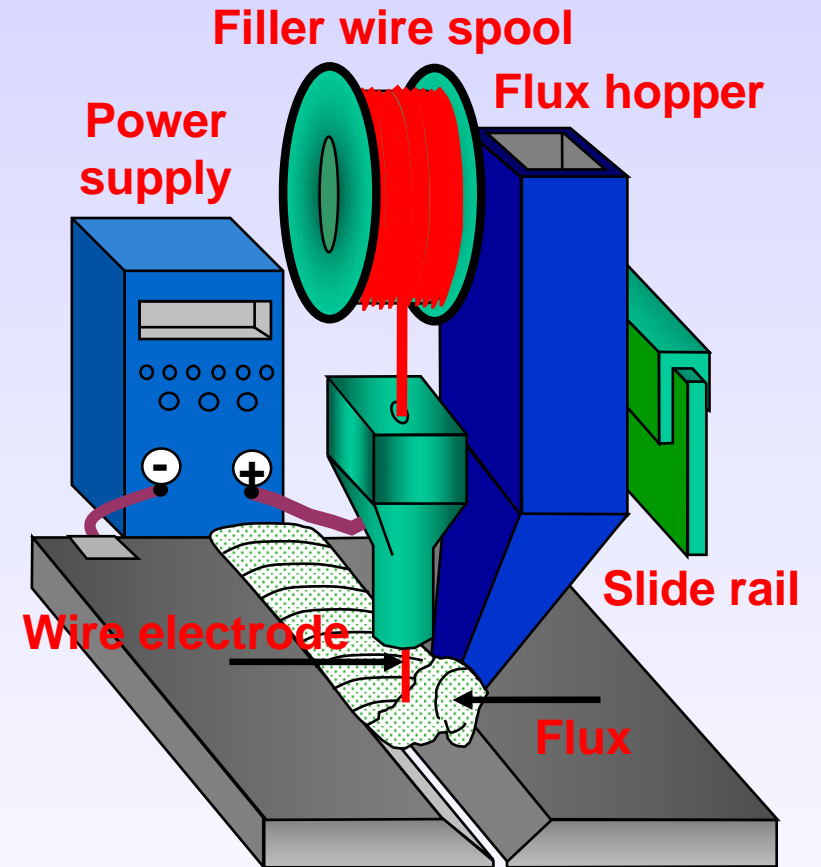

Sub~arc Welding.

.SAW.

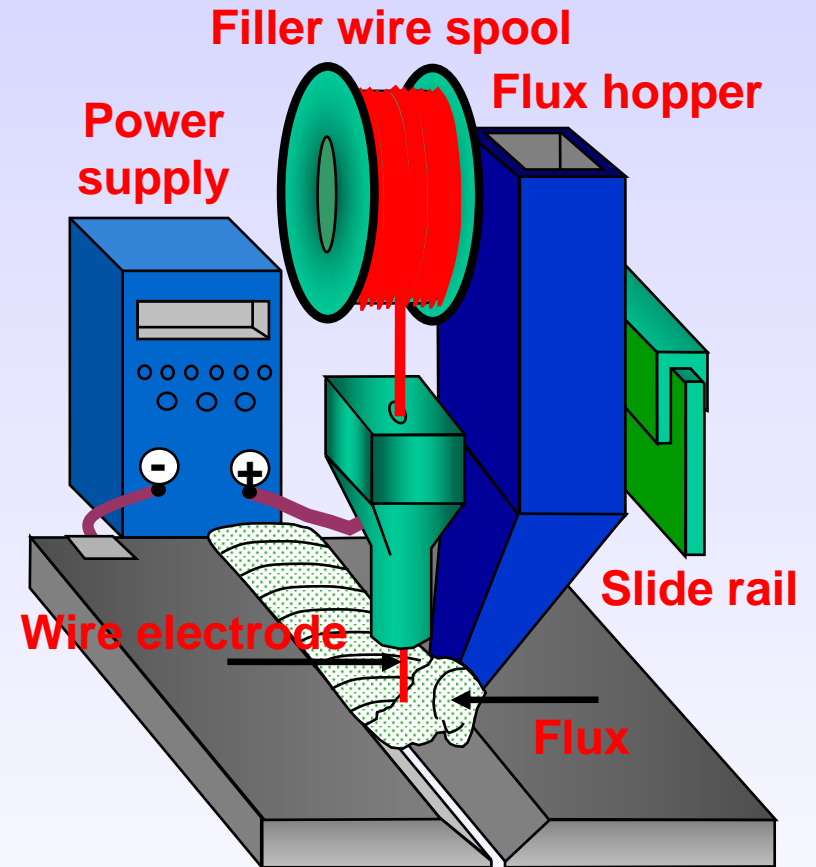

Sub~arc.Welding.basic. equipment

TECHNOLOGY

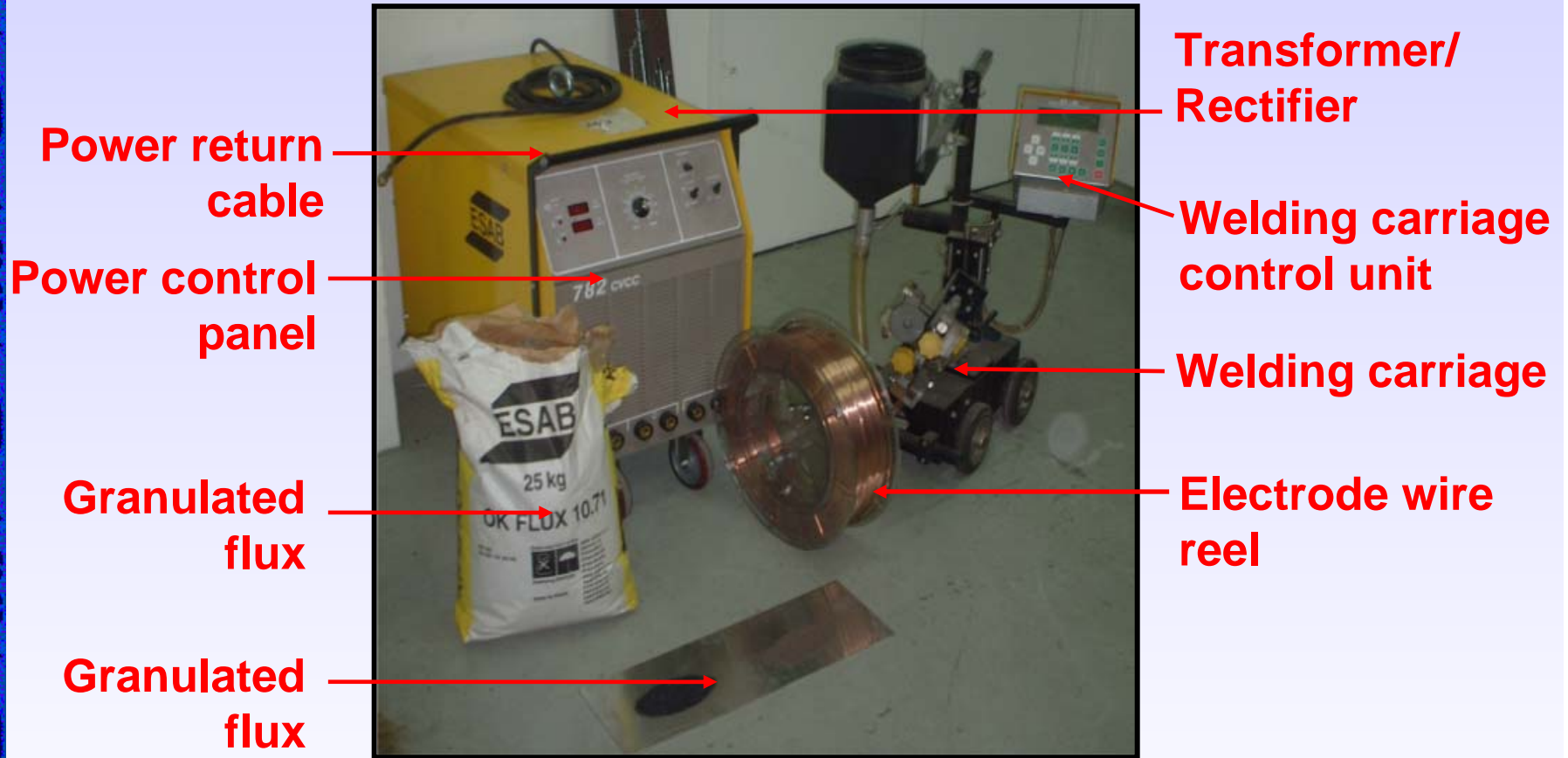

Sub~arc Welding.. SAW.. Fluxes



Fused SAW
Fluxes



Agglomerated SAW
Fluxes

Sub~arc Welding..SAW..

Fluxes

Fused Flux

- Flaky appearance
- Lower weld quality
- Low moisture intake
- Low dust tendency
- Good re-cycling
- Very smooth weld profile

Agglomerated Flux

- Granulated appearance
- High weld quality
- Addition of alloys
- Lower consumption
- Easy slag removal
- Smooth weld profile

Advantages . . .

~~Disadvantages~~**Advantages**

- Low weld-metal cost
- Easily automated
- Low levels of ozone
- High productivity
- No visible arc light
- Minimum cleaning

Disadvantages

- Restricted welding positions
- Arc blow on DC current
- Shrinkage defects
- Difficult penetration control
- Limited joints



Any Questions

TECHNOLOGY



Questions

- QU 1. State the possible problems when using damp and contaminated fluxes when using the sub-arc process
- QU 2. State the two flux types used in the sub-arc welding process.
- QU 3. Generally what power source characteristic is required for the SAW welding process
- QU 4. State three main items of sub-arc fluxes, which require inspection
- QU 5. State the advantages and disadvantages of the sub-arc welding process

Electroslag Welding..ESW.

TECHNOLOGY

Consumable-Guide

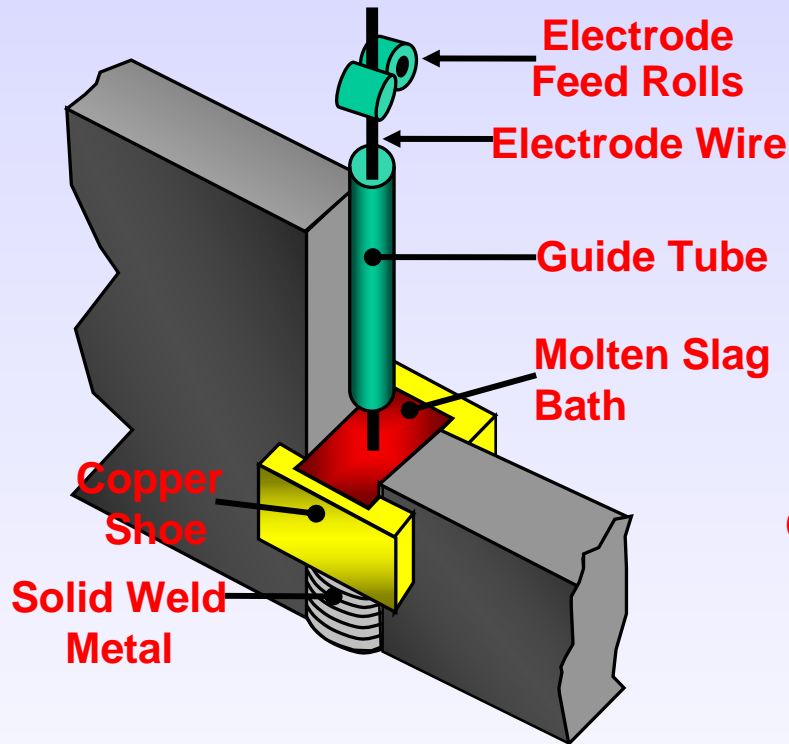

More suitable for short weld lengths and mechanically simpler. Can also be used in portable models.

Non Consumable-Guide

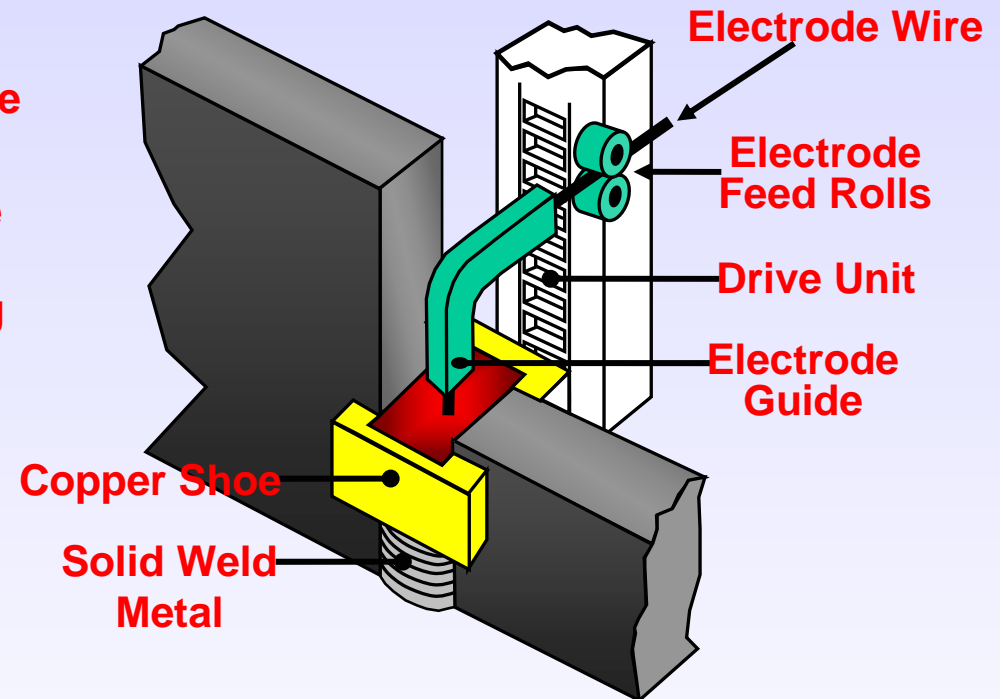

More suitable for longer weld lengths and mechanically more complicated.

Electro-slag Welding..ESW.

- Electro-slag welds are relatively defect free
- More suited to the joining of thick materials
- No costly joint edge preparations required, square butt
- Minimal distortion
- Minimal pre-heat required
- Low flux consumption
- High deposition
- Vertical up welding position only
- Low toughness values, may require PWHT.
- Timely Set-ups

Process Comparisons

| Process | Electrical characteristic | Electrode current type |
|--------------|------------------------------------------------------------------------|------------------------|
| MMA | Drooping / constant current | DC+ve, DC-ve, AC |
| TIG | Drooping / constant current | DC-ve, AC |
| MIG/MAG | Flat / constant voltage | DC+ve, |
| MAG FCAW | Flat / constant voltage | DC+ve, DC-ve, |
| Sub-arc | Drooping / constant current >500amp Flat / constant voltage <500amp | DC+ve, DC-ve, AC |
| Electro-slag | Flat / constant voltage | DC+ve, |



Any Questions

TECHNOLOGY

